

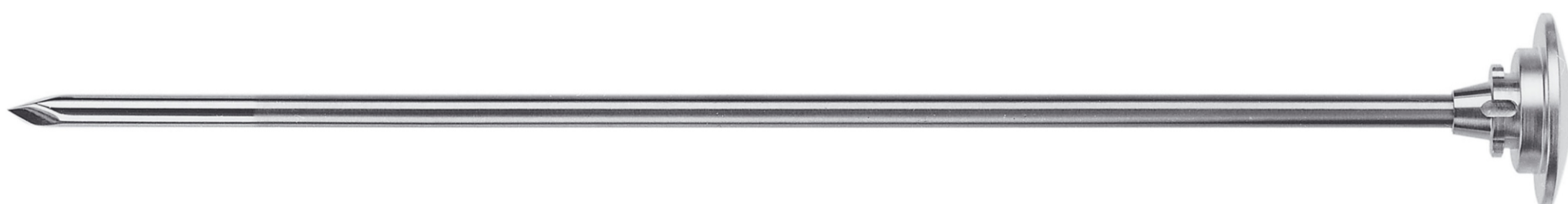

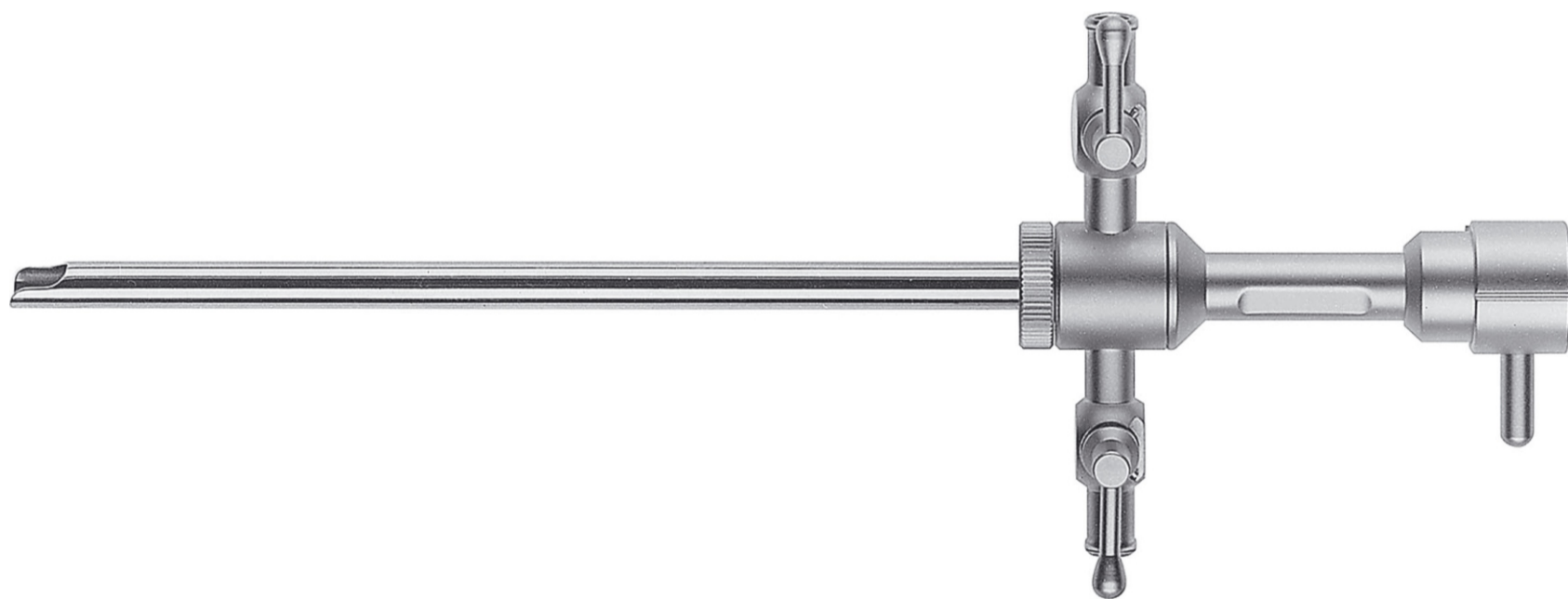

DocTools

Medical Supplies

ARTROSCOPIA

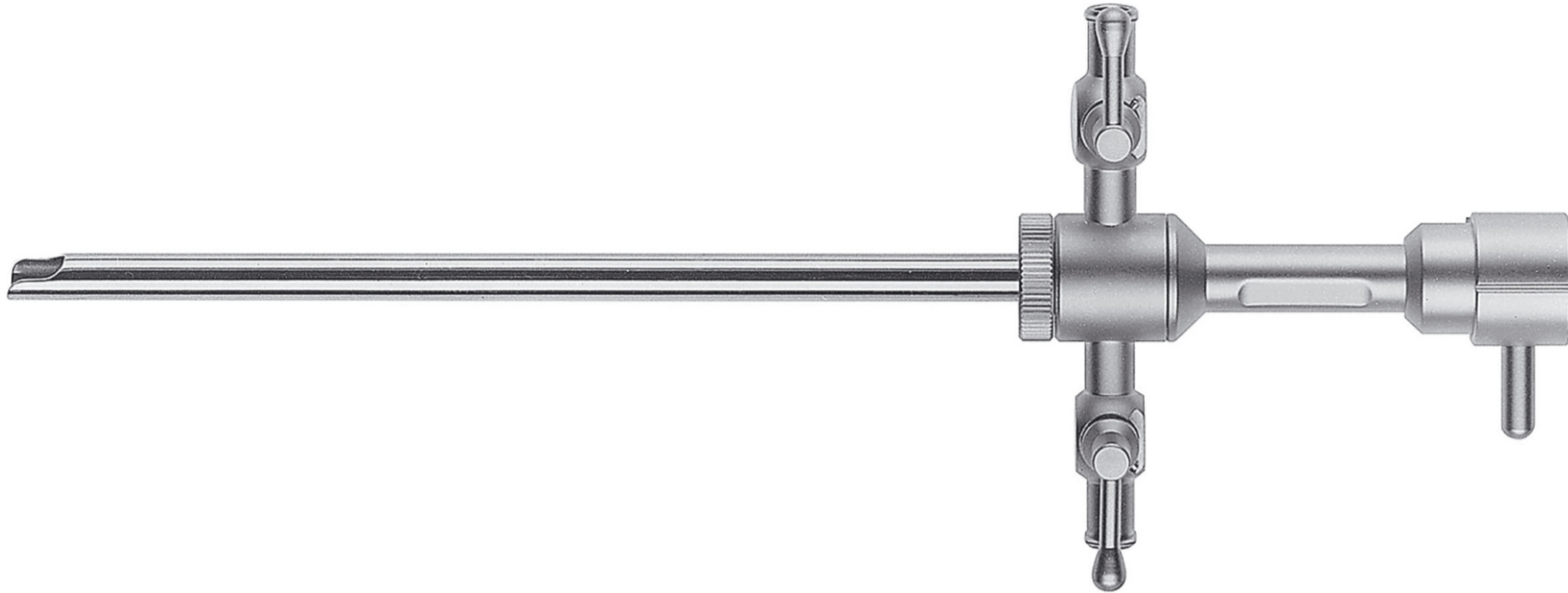

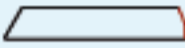

Camisa com 02 válvulas giratórias	∅ ótica (mm)	comprimento da ótica (mm)	Modelo  universal	Modelo  30°
Ponteira				
	2,7	175	ASA 02798 /99	ASA 02797 /99
	2,7	187,5	ASA 02798 /99/187,5	ASA 02797 /99/187,5
	4	175	ASA 04098 /99	ASA 04097 /99
High-flow	4	175	ASA 05098 /99	ASA 05097 /99

Trocáteres e obturadores: ver página 3

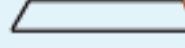

Camisa com 01 válvula giratória	∅ ótica (mm)	comprimento da ótica (mm)	Modelo  universal	Modelo  30°
Ponteira				
	2,7	175	ASA 02798 /97	ASA 02797 /97
	2,7	187,5	ASA 02798 /97/187,5	ASA 02797 /97/187,5
	4	175	ASA 04098 /97	ASA 04097 /97
High-flow	4	175	ASA 05098 /97	ASA 05097 /97

Trocáteres e obturadores: ver página 3

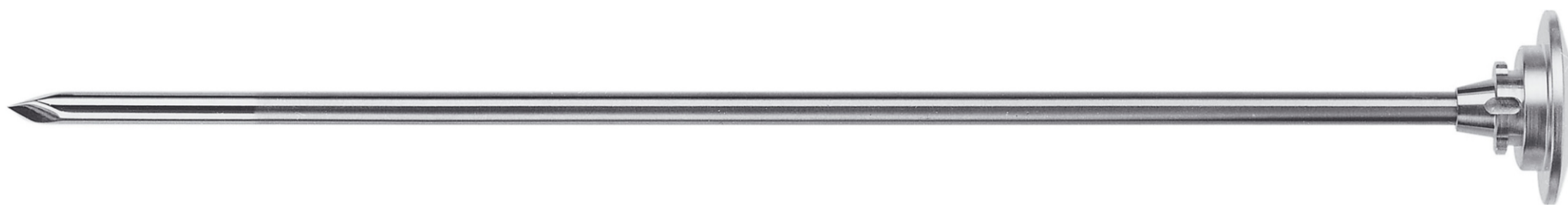

Trocáter piramidal	∅ ótica	comprimento ótica	modelo
	2,7	175	AST 02799
	2,7	187,5	AST 02799 /187,5
para fluxo intenso	4	175	AST 04099
	4	175	AST 05099





Obturador rombo	∅ ótica	comprimento ótica	modelo
	2,7	175	AST 02789
	2,7	187,5	AST 02789 /187,5
para fluxo intenso	4	175	AST 04089
	4	175	AST 05089



Obturador cônico	∅ ótica	comprimento ótica	modelo
	2,7	175	AST 02788
	2,7	187,5	AST 02788 /187,5
para fluxo intenso	4	175	AST 04088
	4	175	AST 05088

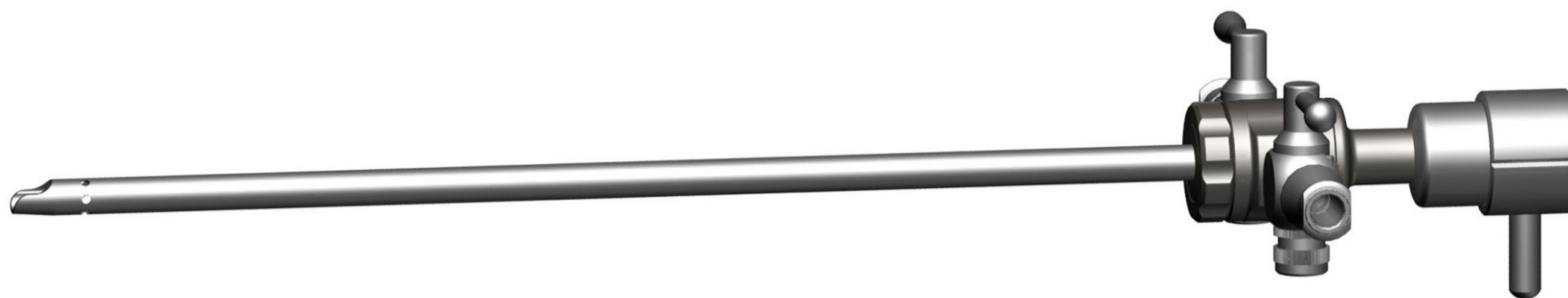

CAMISA ARTROSCÓPICA PARA PEQUENAS ARTICULAÇÕES, HIGH-FLOW

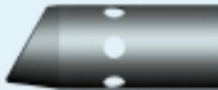

Camisa com 02 válvulas giratórias	∅ ótica	comprimento da ótica (mm)	∅ externo	modelo	modelo
ponteira					
				universal	30°
	2,7	175	4,5	201-239-175	201-237-175
	2,7	187,5	4,5	201-239-187	201-237-187
	4	175	6	201-249-175	201-247-175

Trocáteres e obturadores: ver página 5



Camisa com 01 válvula giratória	∅ ótica	comprimento da ótica (mm)	∅ externo	modelo	modelo
ponteira					
				universal	30°
	2,7	175	4,5	201-139-175	201-137-175
	2,7	187,5	4,5	201-139-187	201-137-187
	4	175	6	201-149-175	201-147-175

Trocáteres e obturadores: ver página 5



Trocáter piramidal	∅	comprimento da ótica	modelo
	2,7	175	201-030-175
	2,7	187,5	201-030-187
	4	175	201-040-175





Obturador rombo	∅	comprimento da ótica	modelo
	2,7	175	201-031-175
	2,7	187,5	201-031-187
	4	175	201-041-175

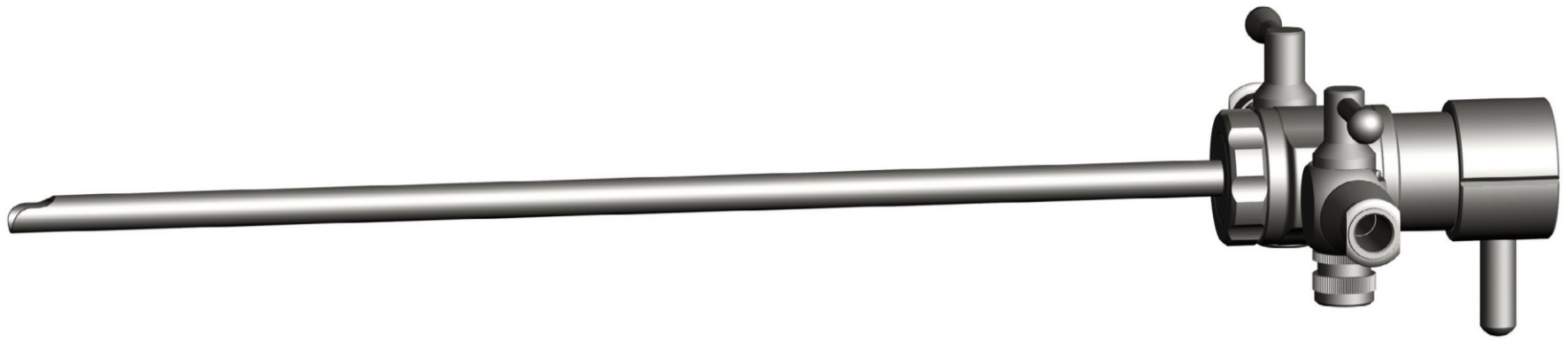

Obturador cônico	∅	comprimento da ótica	modelo
	2,7	175	201-032-175
	2,7	187,5	201-032-187
	4	175	201-042-175



camisa com 02 válvulas giratorias	∅ ótica	comprimento da ótica	∅ externo	 universal	 30°	 0°
	2	58	2,5	-	-	ASA 02099 /99/58
	2	104	2,5	-	-	ASA 02099 /99/104
	2,7	110	4	ASA 02798 /99/110	ASA 02797 /99/110	-



Trocáter piramidal	∅	comprimento ótica	modelo
	2,7	110	AST 02799 /110



Trocáter cônico	∅	comprimento ótica	modelo
	2	58	AST 02099 /58
	2	104	AST 02099 /104



Obturador rombo	∅	comprimento ótica	modelo
	2	58	AST 02089 /58
	2	104	AST 02089 /104
	2,7	110	AST 02789 /110



Cânula de irrigação,
composta por: camisa + trocáter piramidal + obturador rombo + adaptador

Comprimento de trabalho	∅	modelo
83mm	4,5mm	INK 04599/99



Cânula de lavagem com válvula,
composta por: cânula + obturador + trocáter



comprimento de trabalho	∅	modelo
70mm	3,2mm	SPK 03299/97/98
70mm	4,5mm	SPK 04599/97/98

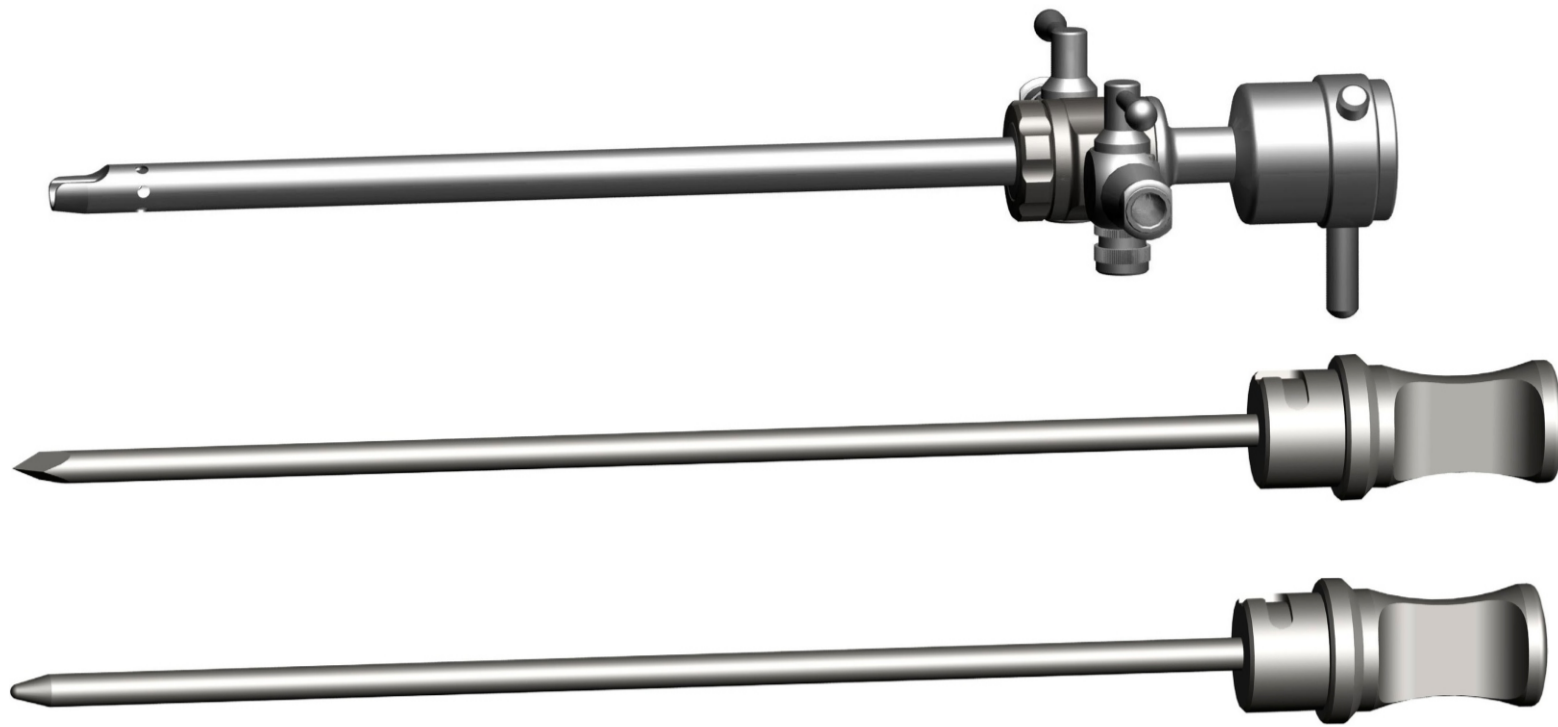

Cânula de lavagem sem válvula,
composta por: cânula + obturador + trocáter

comprimento de trabalho	∅	modelo
70mm	3,2mm	SPK 03296/97/98



Camisa com 02 válvulas giratórias	∅ ótica	comprimento de trabalho	∅ externo	modelo	modelo
ponteira				 universal	 30°
	4	120,6	6	203-249-106	203-247-106
trocáter piramidal obturador cônico				203-040-106	
				203-042-106	

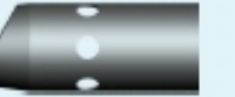

Camisa com 01 válvula giratória	∅ ótica	comprimento de trabalho	∅ externo	modelo	modelo
ponteira				 universal	 30°
	4	120,6	6	203-149-106	203-147-106
trocáter piramidal obturador cônico				203-040-106	
				203-042-106	

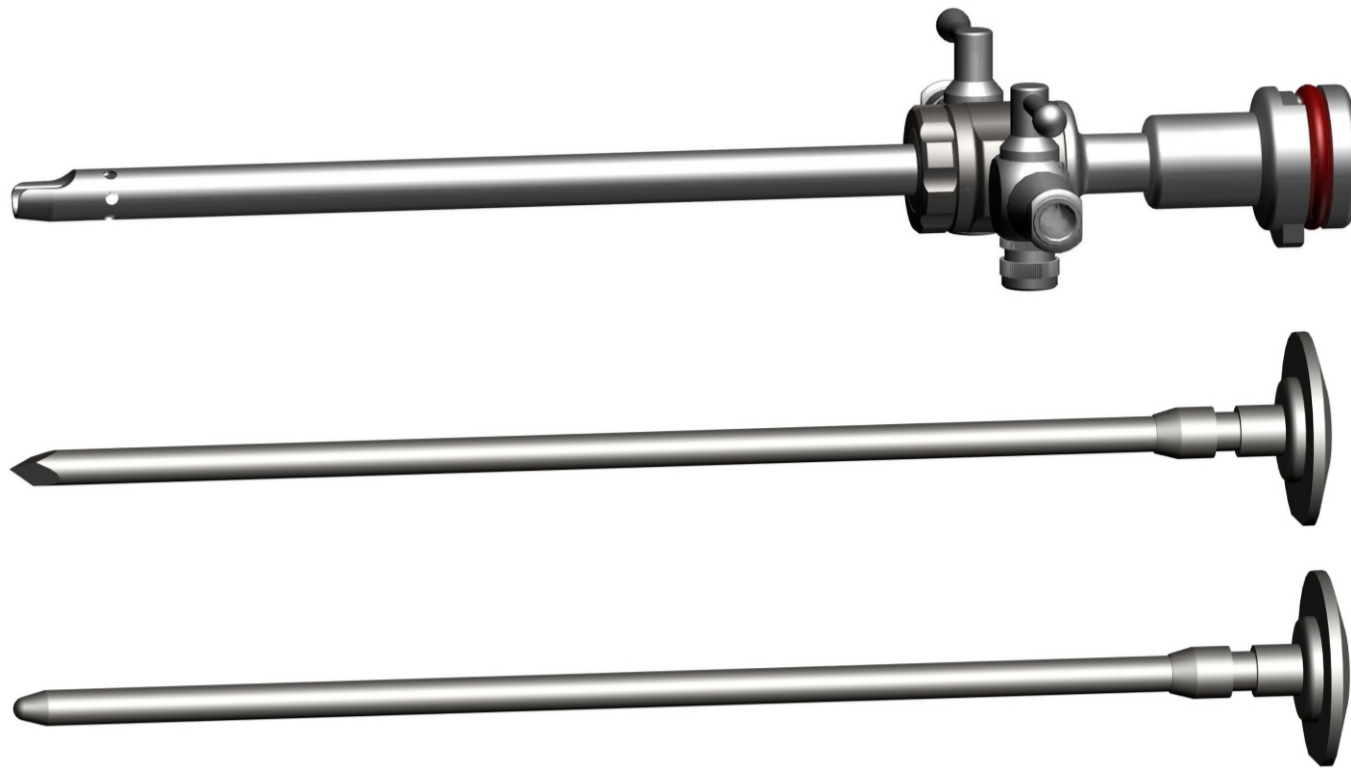

Camisa com
02 válvulas giratórias

∅ ótica

comprimento
de trabalho

∅ externo

modelo

modelo



universal

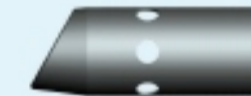

30°

ponteira

trocáter piramidal
obturador cônico

202-040-092

202-042-092

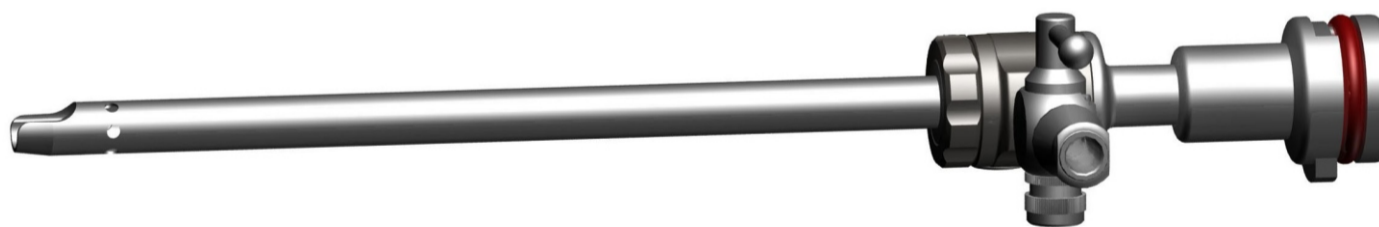

Camisa com
01 válvula giratória

∅ ótica

comprimento
de trabalho

∅ externo

modelo

modelo



universal

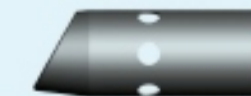

30°

ponteira

202-149-092



202-147-092

trocáter piramidal
obturador cônico

202-040-092

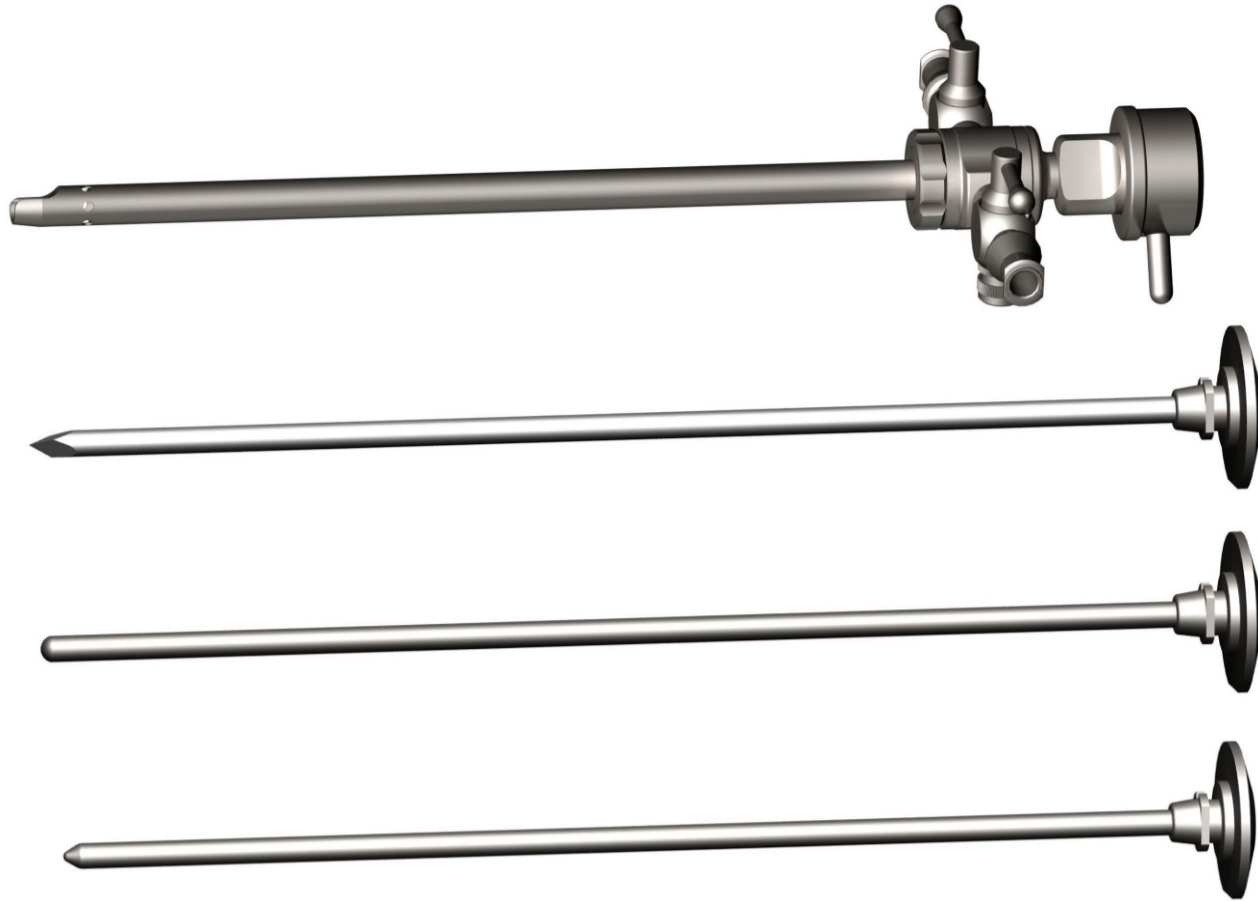
202-042-092



Camisa com 02 válvulas giratórias	∅ ótica	comprimento de trabalho	∅ externo	modelo	modelo
ponteira				 universal	 30°
	4	106,5	6	204-249-170	204-247-170
Trocáter piramidal				204-040-170	
Obturador rombo				204-041-170	
Obturador cônico				204-042-170	

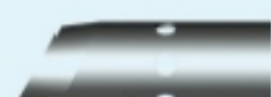

Camisa com 01 válvula giratória	∅ ótica	comprimento de trabalho	∅ externo	modelo	modelo
ponteira				 universal	 30°
	4	106,5	6	204-149-170	204-147-170
Trocáter piramidal				204-040-170	
Obturador rombo				204-041-170	
Obturador cônico				204-042-170	

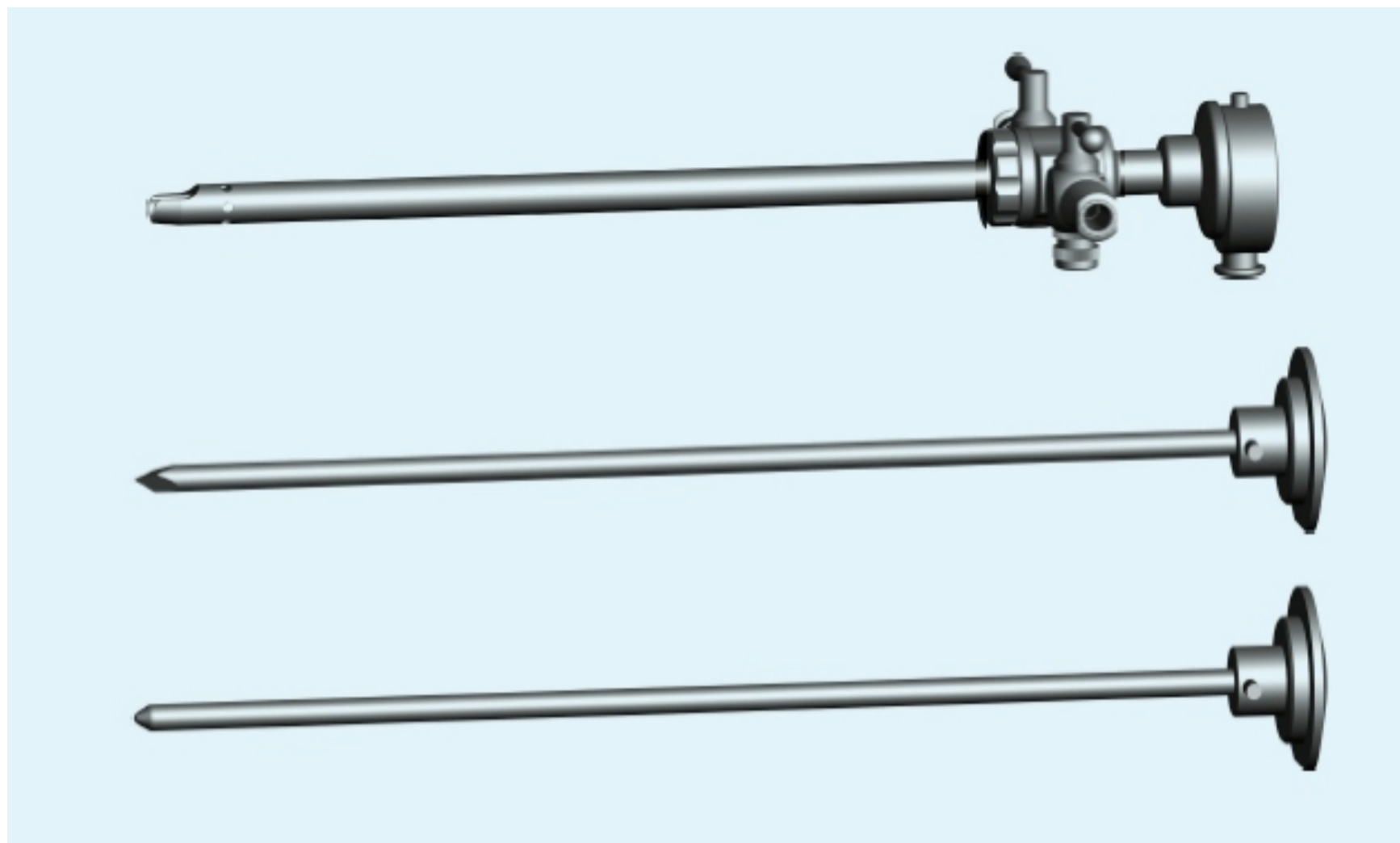

Pedido mínimo para os itens desta página: 50 peças

Dimensões são produzidas de acordo com o tamanho do artroscópio

Artroscópio

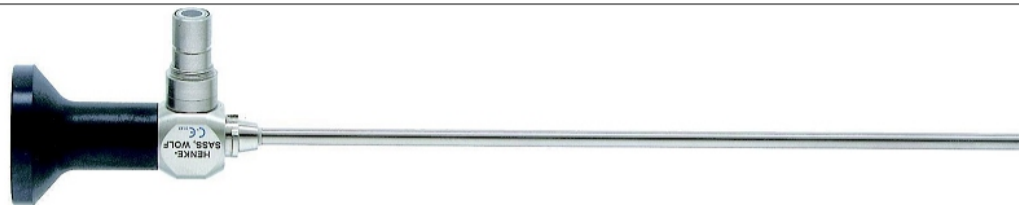

modelo n°	registro Anvisa	comprimento de trabalho	diâmetro	ângulo de visão	campo de visão	observações	compatibilidade
7197201900	80440170020	60mm	1,9mm	0°	65°		Karl Storz
7197201930	80440170020	60mm	1,9mm	30°	65°		Karl Storz
7197202700	80440170020	140mm	2,7mm	0°	80°		Karl Storz
7197202730	80440170020	140mm	2,7mm	30°	80°		Karl Storz
7197202770	80440170020	140mm	2,7mm	70°	80°		Karl Storz
7197252700	80440170020	195mm	2,7mm	0°	80°		Karl Storz
7197252730	80440170020	195mm	2,7mm	30°	80°		Karl Storz
7197252770	80440170020	195mm	2,7mm	70°	80°		Karl Storz
7197230409	80440170020	185mm	4mm	0°	105°	HD	Karl Storz
7197230439	80440170020	185mm	4mm	30°	105°	HD	Karl Storz
7197230479	80440170020	185mm	4mm	70°	105°	HD	Karl Storz
8300009091	80440170020	185mm	4mm	0°	105°		Karl Storz
8300003242	80440170020	185mm	4mm	30°	105°		Karl Storz
8300009090	80440170020	185mm	4mm	70°	105°		Karl Storz

ótica standard
576 linhas

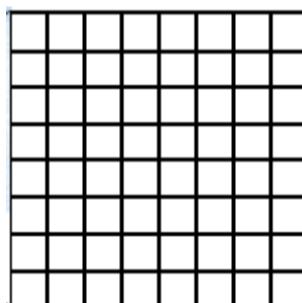

ótica HD
1080 linhas

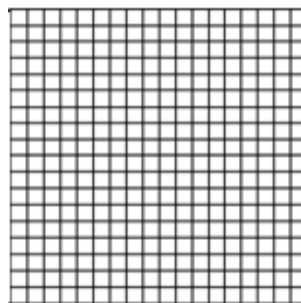

DISTORÇÃO DE IMAGEM

standard

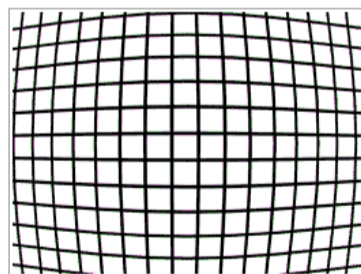

HD

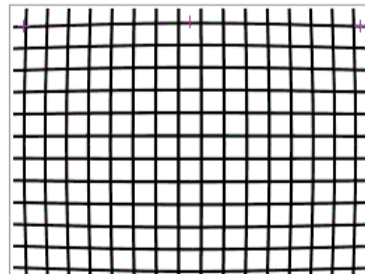

Artroscópio



modelo n°	registro Anvisa	comprimento de trabalho	diâmetro	ângulo de visão	campo de visão	observações	compatibilidade
30-0250-00	80440170021	69mm	1,9mm	30°			Karl Storz
30-0254-00	80440170021	69mm	1,9mm	0°			Karl Storz
30-0255-00	80440170021	102mm	1,9mm	30°			Karl Storz
30-0256-00	80440170021	102mm	1,9mm	0°			Karl Storz
30-0025-00	80440170021	98mm	2,4mm	0°			Karl Storz
30-0001-00	80440170021	110mm	2,7mm	0°	90°		Karl Storz
30-0002-00	80440170021	110mm	2,7mm	30°	90°		Karl Storz
30-0002-01	80440170021	110mm	2,7mm	25°			Richard Wolf
30-0003-00	80440170021	110 mm	2,7mm	70°	80°		Karl Storz
30-0003-01	80440170021	110 mm	2,7mm	70°			Richard Wolf
30-0004-00	80440170021	175mm	2,7mm	0°	90°		Karl Storz
30-0005-00	80440170021	175mm	2,7mm	30°	90°		Karl Storz
30-0006-00	80440170021	175mm	2,7mm	70°	90°		Karl Storz
30-0007-00	80440170021	187,5mm	2,7mm	0°	90°		Karl Storz
30-0008-00	80440170021	187,5mm	2,7mm	30°	90°		Karl Storz
30-0009-00	80440170021	187,5mm	2,7mm	70°	90°		Karl Storz
30-0027-00	80440170021	98mm	4mm	30°			Karl Storz
30-0011-03	80440170021	141mm	4mm	30°			Stryker
30-0202-00	80440170021	142mm	4mm	30°			Aesculap
30-0011-02	80440170021	160mm	4mm	30°			Dyonics
30-0010-01	80440170021	170mm	4mm	0°			Richard Wolf
30-0011-01	80440170021	170mm	4mm	25°			Richard Wolf
30-0012-01	80440170021	170mm	4mm	70°			Richard Wolf
30-0010-00	80440170021	175mm	4mm	0°			Karl Storz
30-0011-00	80440170021	175mm	4mm	30°			Karl Storz
30-0085-00	80440170021	175mm	4mm	45°	95°		Karl Storz
30-0012-00	80440170021	175mm	4mm	70°			Karl Storz
30-0024-00	80440170021	175mm	4,3mm	0°		canal de trabalho de ø 1,8mm	Karl Storz



DocTools

Medical Supplies



DocTools

Av. Nações Unidas, 3290
CEP 93.320-020
Novo Hamburgo (RS)
Fone: 051 3594 9077
Fax: 051 3594 8449
e-mail: info@dtm-intl.com

DTM International Trading Ltd.

Dongguan city,
Guangdong Province,
China
Phone: +86 769 223 03043
Fax: +86 769 223 03049
e-mail: cnmanager@dtm-intl.com